

INSTALLATION INSTRUCTIONS

DAN DRYER toilet roll holder with shelf/ 5035-5037

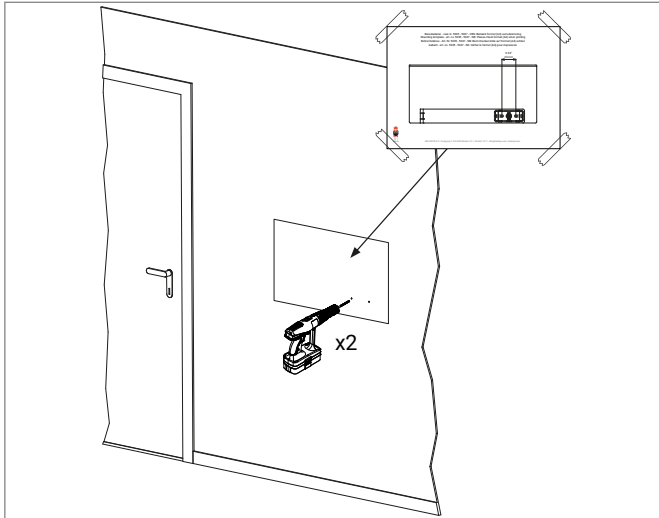

1. Place the mounting template on the wall at your desired location, and drill holes for the mounting bracket.



2. Remove the foil from the tape.

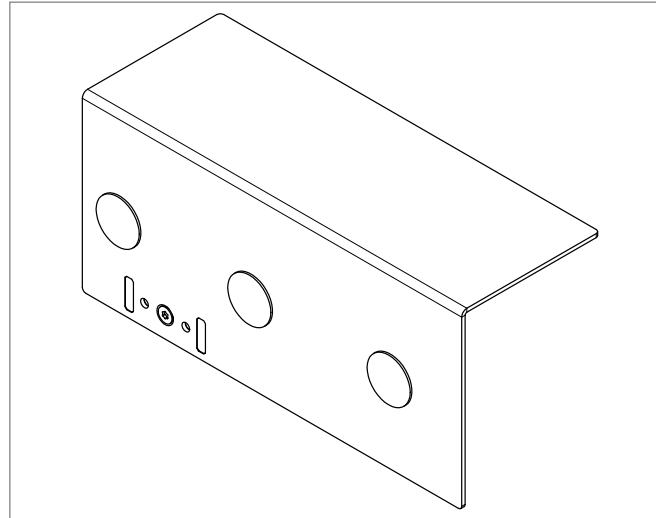

3. The bracket is placed on the wall, and fastened using screws and dowels suitable for the wall used.

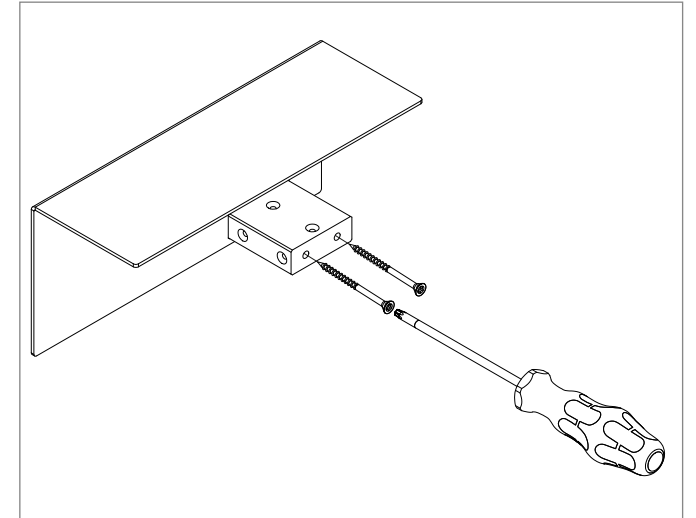

4. Place the flatiron on the bracket.

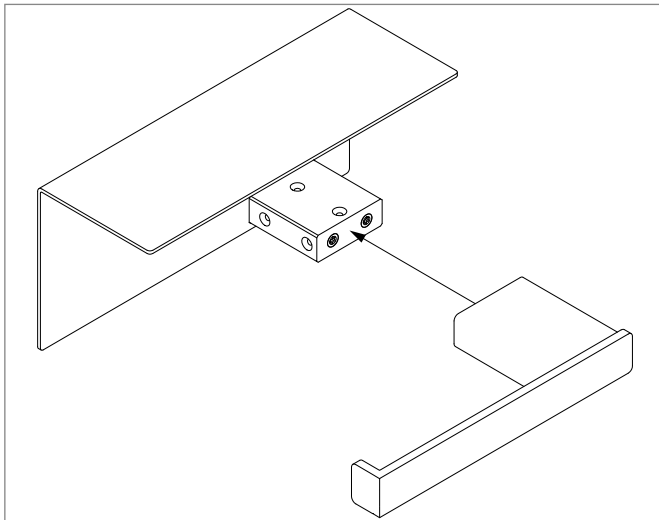

5. Fasten the flatiron to the bracket using M4X10 screws.

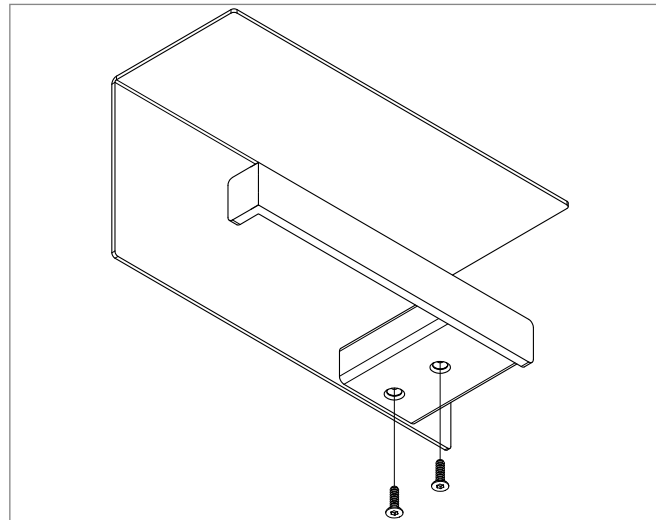

6. Place a toilet roll on the handle. The toilet roll holder is now ready to use.

